

**ALU-RACK BMW G 650 X-Challenge & X-Moto**  
ALU-RACK BMW G 650 X-Challenge & X-Moto

**Montagehinweise**

Alle vom Motorrad gelösten Schrauben sind gemäß Herstellerangaben wieder zu montieren, oder mit von SW-MOTECH gelieferten Schrauben zu ersetzen. Falls nicht anderweitig definiert, diese Schrauben nach Tabelle anziehen:

M6	9,6 Nm
M8	23 Nm

Gegebenenfalls Schrauben mit flüssiger Schraubensicherung einkleben.

Prüfen Sie nach 50 km alle Verbindungen auf festen Sitz.

Max. Zuladung 5 Kg inklusive Koffer und Adapter.  
Ist das Zuladungsgewicht des Fahrzeuges durch den Hersteller limitiert, gelten diese Grenzwerte.

**Mounting Instruction**

SW-MOTECH products should be installed by a qualified, experienced motorcycle technician. If you are unsure of your ability to properly install a product, please have the product installed by your local motorcycle dealer. SW-MOTECH takes no responsibility for damages caused by improper installation.

All screws, bolts and nuts, including all replacement hardware provided by SW-MOTECH, should be tightened to the torque specified in the OEM maintenance manual for your motorcycle. If no torque specifications are provided in the OEM maintenance manual, the following torques may be used:

M6	9,6 Nm
M8	23 Nm

All screws, bolts and nuts should be checked after driving the first 50 km to ensure that all are tightened to the proper torque.

Medium strength liquid thread-locker (i.e., "Locktite") should be used to secure all screws, bolts and nuts.

Max. Load On Rear Carrier: 5 Kg (11 lbs) inclusive case and adapter or the motorcycle manufacturer's weight limit, whichever is less.

SW-MOTECH GmbH & Co. KG  
Bahnhofstrasse 44d  
35282 Rauschenberg  
-Germany-

Tel.: ++ 49 (0) 6425 816 800  
Fax: ++ 49 (0) 6425 816 810

www.sw-motech.com

1 ALU-RACK  
ALU-RACK



schwarz/silber  
GPT.07.613.001 01  
Anzahl/ Pcs. 1

2 Senkkopfschraube  
Counter Sunk Screw



schwarz/silber  
M6 x 25 DIN 7991  
Anzahl/ Pcs. 4

3 Senkscheibe  
Counter Sunk Washer



schwarz/silber  
SE.00.064.02/01  
Anzahl/ Pcs. 4

4 Mutter mit Bund,  
selbstsichernd  
Lock Nut with Flange



schwarz/black  
M6 DIN 6927  
Anzahl/ Pcs. 4

5 Anschraublech rechts  
Support Bracket  
right side



schwarz/black  
GPT.07.613.002 02  
Anzahl/ Pcs. 1

6 Senkkopfschraube  
Counter Sunk Screw



schwarz/black  
M6 x 40 DIN 7991  
Anzahl/ Pcs. 4

7 Senkscheibe  
Counter Sunk Washer



schwarz/black  
SE.00.064.02  
Anzahl/ Pcs. 4

8 Anschraublech links  
Support Bracket  
left side



schwarz/black  
GPT.07.613.003 02  
Anzahl/ Pcs. 1

9 Distanzbuchse  
Spacer



schwarz/black  
Da:20 Di:6,4 h:15  
Anzahl/ Pcs. 2

10 Distanzbuchse  
Spacer



schwarz/black  
Da:20 Di:6,4 h:17  
Anzahl/ Pcs. 2

11 Innensechskantschraube  
Hexagon Socket Screw



schwarz/black  
M8 x 50 DIN 912  
Anzahl/ Pcs. 1

12 Distanzbuchse  
Spacer



schwarz/black  
Da:18 Di:8,4 h:8  
Anzahl/ Pcs. 1

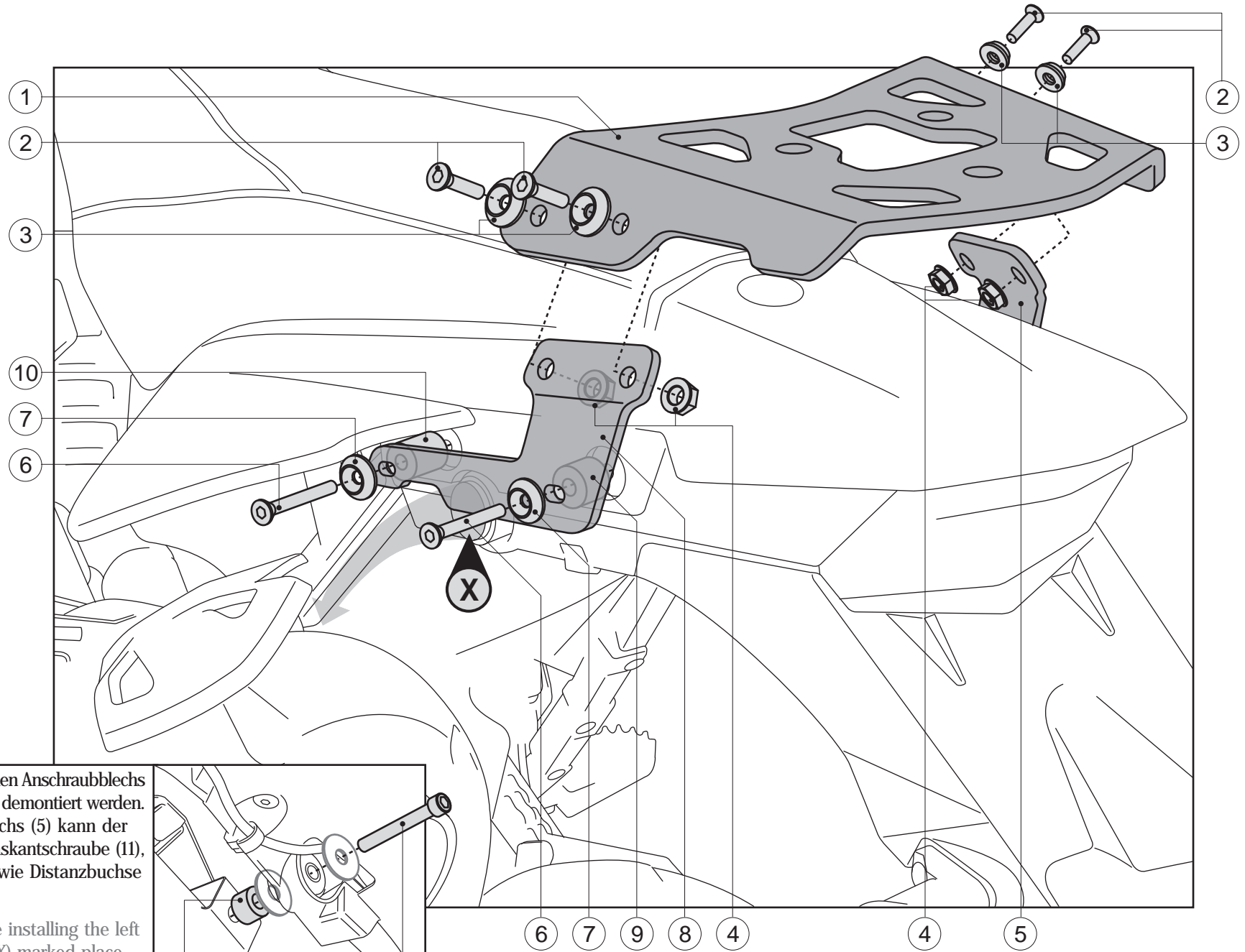

Auspuff muss vor Montage des linken Anschraubblechs (5) an der mit (X) markierten Stelle demontiert werden. Nach Montage des Anschraubblechs (5) kann der Auspuff wie gezeigt mit Innensechskantschraube (11), der Original Unterlegscheiben sowie Distanzbuchse (12) montiert werden

Exhaust must be removed before installing the left side support bracket (5) at the (X)-marked place. After installation of fixing bracket (5) attach the exhaust together with hexagon socket screw (11), the original washers and spacer (12) as shown.

